

Technical data sheet

Spacer clip 733 ALU

Item number: 1362804



Spacer clip for the installation of pipes and cables on walls, ceilings and floors. With self-locking upper part. Fastening via slot. From the clip size of 20 suitable for installation with a nail device or bolt-firing device.

Approved for the maintenance of electrical function to DIN 4102 Part 12, maintenance of electrical function classes E30 to E90 (except ALU).



Alu Aluminium

Master data

Item number	1362804
Description 1	Distance saddle
Description 2	with slot
Manufacturer	OBO
Dimension	8-10mm
Material	Aluminium
Smallest sales unit	25
Unit of quantity	Piece
Weight	0.917 kg
Weight unit	kg/100 pc.

Technical data sheet

Spacer clip 733 ALU

Item number: 1362804



Dimensions

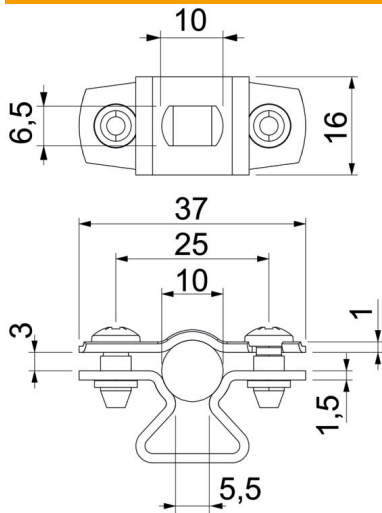

Dimension A	37 mm
Dimension B	25 mm
Dimension b	16 mm
Dimension D	10 mm
Dimension d max.	10 mm
Dimension d min.	8 mm
Dimension L	10 mm
Dimension s	5.5 mm
Dimension t1 (mm)	1
Dimension t2 (mm)	1.5
Dimension x	3 mm

Technical data

Distance to the wall	yes
Number of cables/pipes	1
Version for	Closed
Fastening type	Screw hole
For diameter	8 - 10
Halogen-free	yes
Plastic-covered	no
Material thickness	1.5 mm
Clamping range D, max.	10 mm
Clamping range D, min.	8 mm
UV-resistant	yes