

Technical data sheet

Centre suspension mesh cable tray FS

Item number: 6015406



Centre suspension including clamping piece for mesh cable tray suspensions.



St Steel

FS Strip galvanized

Master data

Item number	6015406
Type	GMS 470 FS
Description 1	Centre suspension
Description 2	for mesh cable tray with clamp
Manufacturer	OBO
Dimension	B470mm
Material	Steel
Surface	Strip galvanized
Surface standard	DIN EN 10346
Smallest sales unit	10
Unit of quantity	Piece
Weight	55 kg
Weight unit	kg/100 pc.

Technical data sheet

Centre suspension mesh cable tray FS

Item number: 6015406



Dimensions

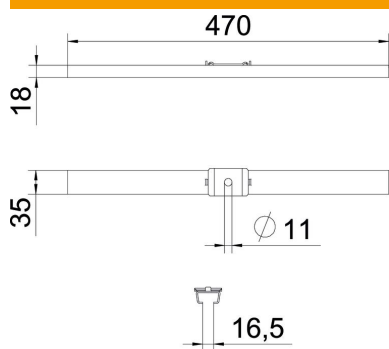

Length	35 mm
Width	470 mm
Height	18 mm
Dimension B	470 mm

Technical data

Version for	Suspended
Maintain electrical functions	no
for width max.	470 mm
for width min.	470
Suitable for metric threaded rod	10
Hole diameter	11 mm
Adjustable	no