

# Technical data sheet

## Centre suspension, universal FT

Item number: 6358896



Universal centre suspension for fastening to threaded rods and supports.  
Preferred use of this centre suspension in combination with cable ladders and mesh cable trays.



**St** Steel

**FT** Hot-dip galvanised

### Master data

Item number	6358896
Type	MAHU 500 FT
Description 1	Centre suspension
Description 2	universal
Manufacturer	OBO
Dimension	B500mm
Material	Steel
Surface	Hot-dip galvanised
Surface standard	DIN EN ISO 1461
Smallest sales unit	1
Unit of quantity	Piece
Weight	89.1 kg
Weight unit	kg/100 pc.

# Technical data sheet

## Centre suspension, universal FT

Item number: 6358896



### Dimensions

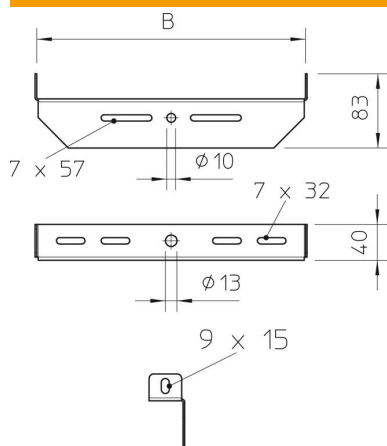

Width	500 mm
-------	--------

### Technical data

Suitable for metric threaded rod	12
Adjustable	no