

Technical data sheet

Cable ladder SLG 45, 3 m FS

Item number: 6200546



Cable ladder with perforated side rail of side height 45 mm with riveted C profile rungs, open in an upwards direction.
The cable ladder is shipped folded up.
You can find the appropriate U clamp of type 2056N in the vertical ladder systems chapter.
Magnetic shield insulation without cover 10 dB, with cover 15 dB.



St Steel

FS Strip galvanized

Master data

Item number	6200546
Type	SLG 440 NS 3 FS
Description 1	Cable ladder
Description 2	heavy, perforated, NS rung
Manufacturer	OBO
Dimension	45x400x3000
Material	Steel
Surface	Strip galvanized
Surface standard	DIN EN 10346
Smallest sales unit	3
Unit of quantity	Metre
Weight	310.2 kg
Weight unit	kg/100 m

Technical data sheet

Cable ladder SLG 45, 3 m FS

Item number: 6200546



Dimensions

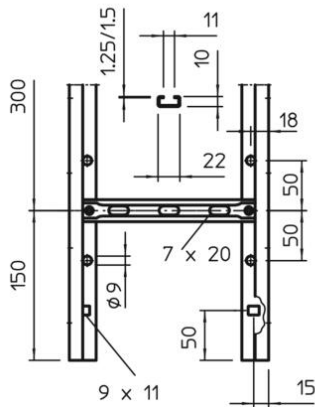
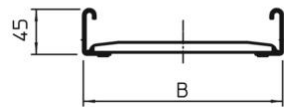
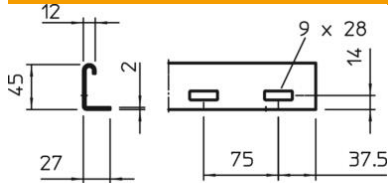

Dimension	45x400x3000
Length	3,000 mm
Length	3,000 ft
Width	400 mm
Height	45 mm
Dimension B	400 mm

Technical data

Side wall version	Profile (open)
Version of the rungs	Profile perforated
Side rail version	Flat profile
Fastening of rung	Blind riveted
Maintain electrical functions	no
Usable cross-section	138 cm ²
Usable cross-section	13800 mm ²
Rustproof steel, pickled	no
Side perforation	yes
Rung distance	300 mm
Wide-span version	no
Rail thickness	2 mm

Technical data sheet

Cable ladder SLG 45, 3 m FS

Item number: 6200546



Loads

Support spacing 1.5 m	2.75 kN/m
Support spacing 2.0 m	2 kN/m
Support spacing 3.0 m	1 kN/m
Support spacing 4.0 m	0.55 kN/m

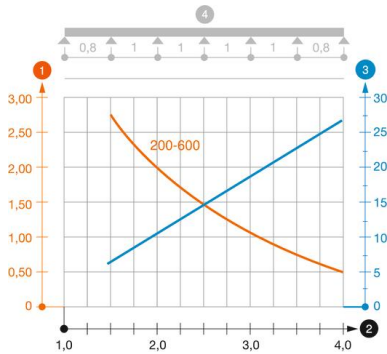

Load diagram, cable ladder, type SLG 45 NS

- 1 Permitted cable tray/ladder load in kN/m without man load
- 2 Support width in m
- 3 Rail bend in mm at permitted kN/m
- 4 Load scheme during testing
- Load curve with cable tray/ladder width in mm
- Strut bend curve according to support width